

Precision Bourdon tube pressure gauges

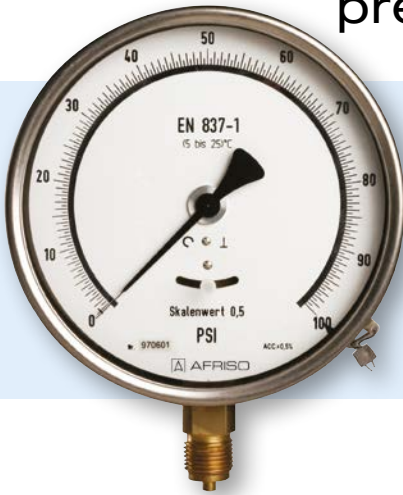

- Very high measuring accuracy (class 0.25) with mirror scale
- Housing can be sealed
- Serial number on dial
- Suitable as measuring equipment according to QA requirements
- DNV- and GOSSTANDART-certified

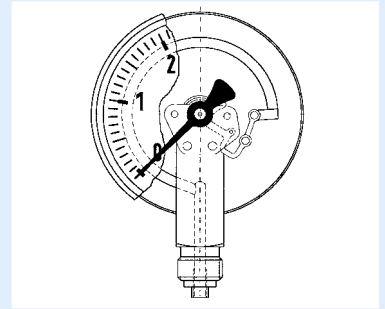

1

Application For gaseous and liquid media which are not corrosive and not highly viscous and which do not crystallise. For very high measuring accuracy.
! For measuring gas or vapour, these gauges must be used in accordance with the table "Selection Criteria as per EN 837-2" (see appendix)!

Technical specifications

Type
D 4

Nominal size
160 – 250

Accuracy class (EN 837-1/6)
0.25

Ranges (EN 837-1/5)
-1/0 bar to -1/+15 bar
0/0.6 to 0/400 bar

Calibration medium
≤ 40 bar: air
> 40 bar: water

Application area
Static load: full scale value
Dynamic load: 0.9 x full scale value

Operating temperature range

Medium: $T_{max} = +60\text{ °C}$
Ambient: $T_{min} = -20\text{ °C}$
 $T_{max} = +60\text{ °C}$

Temperature performance

Indication error when the temperature of the measuring system deviates from the normal temperature of 20 °C:
rising temperature approx. $\pm 0.4\text{ \%}/10\text{ K}$
falling temperature approx. $\pm 0.4\text{ \%}/10\text{ K}$
of full scale value

Degree of protection

IP 54 (EN 60529)

Standard version

Connection

Brass, bottom or bottom back
(NG 160 only)
G½B – spanner size SW 22 (EN 837-1/7.3)

Measuring element

Bourdon tube
≤ 100 bar "C" type tube, copper alloy
> 100 bar helical tube, copper alloy

Movement

Brass/nickel silver, ball bearing

Dial

Aluminium, white
Dial marking black
NG 160 mirror scale 270°
NG 250 mirror scale 330°
with zero correction

Pointer

Knife edge pointer
Aluminium

Housing

Stainless steel 304

Bayonet type bezel

Stainless steel 304

Window

Plastic (PMMA)



See page 83
for prices.

Options

- Factory test certificates
- Back flange (NG 160)
- 3-hole fixing, panel mounting bezel (NG 160)
- Special scales
- Other process connections

Precision Bourdon tube pressure gauges

Type D 4 – NG 160/250

1 Housing types and dimensions

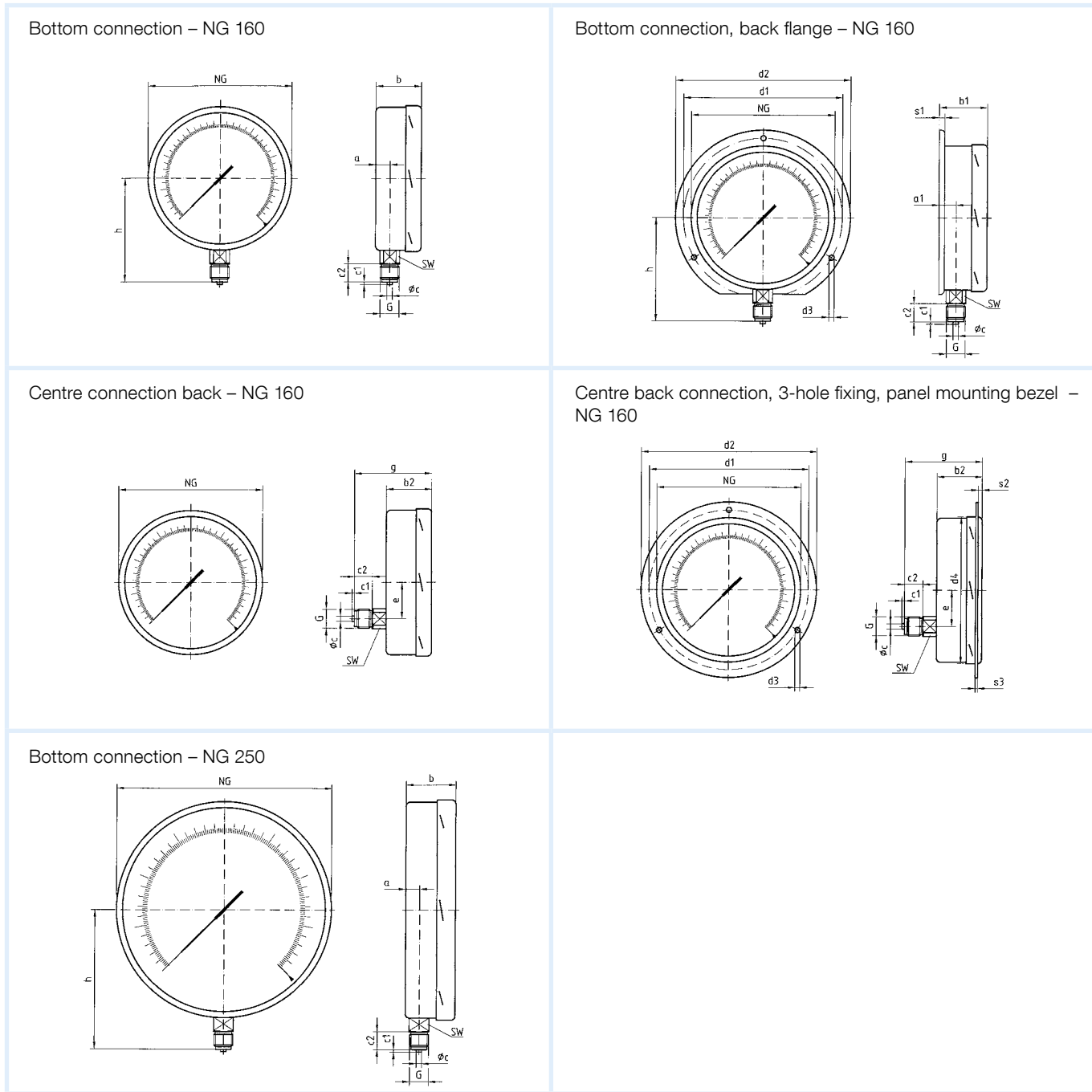

Dimensions (mm)

Nominal size (NG)	a	a1	b	b1	b2	b3	Øc	c1	c2	d1*	d2	d3*	d4	d5	d6	e	G	g	g1	h	s1
160	17.5	20.5	50	53	50	52	6	3	20	178	196	5.8	164	167	161	44.5	G½B	82	84	116	6
250	16	-	57	-	-	-	6	3	20	-	-	-	-	-	-	-	G½B	-	-	165	-
Nominal size (NG)	s2	s3	s4	SW																	
160	4	2	4.5	22																	
250	-	-	-	22																	

* Dimensions as per DIN 16070.

Precision Bourdon tube pressure gauges

DG: M

1

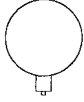
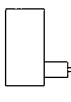
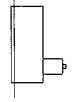
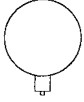
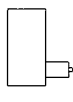
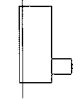
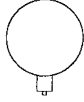

Type	RF160F, D401	RF160F, D411	RF160F, D431	RF160ChF, D402	RF160ChF, D412	RF160ChF, D432	RF250F, D401
Version							
Housing Ø	160	160	160	160	160	160	250
Housing	Stainless steel 304 with bayonet bezel						
Measuring element	Bourdon tube, copper alloy, (100 bar 316 Ti/316 L)			Bourdon tube, stainless steel 316 Ti/316 L			Cu alloy
Accuracy class	0.6	0.6	0.6	0.6	0.6	0.6	0.6
Connection	G½B	G½B	G½B	G½B	G½B	G½B	G½B
			3-hole fixing, panel mounting bezel, stainless steel			3-hole fixing, panel mounting bezel, stainless steel	
PG	2	2	2	3	3	3	2
Range (bar)	Part no.	Part no.	Part no.	Part no.	Part no.	Part no.	Part no.
Price €							
-1/0	85701401	85701411	85701431	85701402	85701412	85701432	85751401
-1/+0.6	85702401	85702411	85702431	85702402	85702412	85702432	85752401
-1/+1.5	85703401	85703411	85703431	85703402	85703412	85703432	85753401
Price €							
-1/+3	85704401	85704411	85704431	85704402	85704412	85704432	85754401
-1/+5	85705401	85705411	85705431	85705402	85705412	85705432	85755401
-1/+9	85706401	85706411	85706431	85706402	85706412	85706432	85756401
-1/+15	85707401	85707411	85707431	85707402	85707412	85707432	85757401
Price €							
0/0.6	85709401	85709411	85709431	85709402	85709412	85709432	85759401
0/1	85710401	85710411	85710431	85710402	85710412	85710432	85760401
0/1.6	85711401	85711411	85711431	85711402	85711412	85711432	85761401
Price €							
0/2.5	85712401	85712411	85712431	85712402	85712412	85712432	85762401
0/4	85713401	85713411	85713431	85713402	85713412	85713432	85763401
0/6	85714401	85714411	85714431	85714402	85714412	85714432	85764401
0/10	85715401	85715411	85715431	85715402	85715412	85715432	85765401
0/16	85716401	85716411	85716431	85716402	85716412	85716432	85766401
0/25	85717401	85717411	85717431	85717402	85717412	85717432	85767401
0/40	85718401	85718411	85718431	85718402	85718412	85718432	85768401
Price €							
0/60	85719401	85719411	85719431	85719402	85719412	85719432	85769401
0/100	85720401	85720411	85720431	85720402	85720412	85720432	85770401
0/160	85721401	85721411	85721431	85721402	85721412	85721432	85771401
0/250	85722401	85722411	85722431	85722402	85722412	85722432	85772401
0/400	85723401	85723411	85723431	85723402	85723412	85723432	85773401
Extra charge glycerine filling (for NG 160 > 2.5 bar) €							

Blue part no. = in-stock items

Precision Bourdon tube pressure gauges

DG: M, PG: 2

1

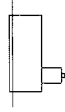
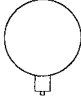
Type	RF160F, D401	RF160F, D411	RF160F, D431	RF250F, D401
Version				
Housing Ø	160	160	160	250
Housing	Stainless steel 304 with bayonet bezel			
Measuring element	Copper alloy			
Dial	Mirror scale 270°			Mirror scale 330°
Accuracy class	0.25	0.25	0.25	0.25
Connection	G½B	G½B	G½B	G½B
			3-hole fixing, panel mounting bezel 304	
Range (bar)	Part no.	Part no.	Part no.	Part no.
Price €				
-1/0	88201401	88201411	88201431	88231401
-1/+0.6	88202401	88202411	88202431	88232401
-1/+1.5	88203401	88203411	88203431	88233401
-1/+3	88204401	88204411	88204431	88234401
-1/+5	88205401	88205411	88205431	88235401
-1/+9	88206401	88206411	88206431	88236401
-1/+15	88207401	88207411	88207431	88237401
0/0.6	88209401	88209411	88209431	88239401
0/1	88210401	88210411	88210431	88240401
0/1.6	88211401	88211411	88211431	88241401
0/2.5	88212401	88212411	88212431	88242401
Price €				
0/4	88213401	88213411	88213431	88243401
0/6	88214401	88214411	88214431	88244401
0/10	88215401	88215411	88215431	88245401
0/16	88216401	88216411	88216431	88246401
0/25	88217401	88217411	88217431	88247401
0/40	88218401	88218411	88218431	88248401
Price €				
0/60	88219401	88219411	88219431	88249401
0/100	88220401	88220411	88220431	88250401
0/160	88221401	88221411	88221431	88251401
0/250	88222401	88222411	88222431	88252401
0/400	88223401	88223411	88223431	88253401

Blue part no. = in-stock items